



ADVANCED
MECHATRONICS
SOLUTIONS, INC

2020 AMS PROFILE

To view our products..

www.ams-fa.com

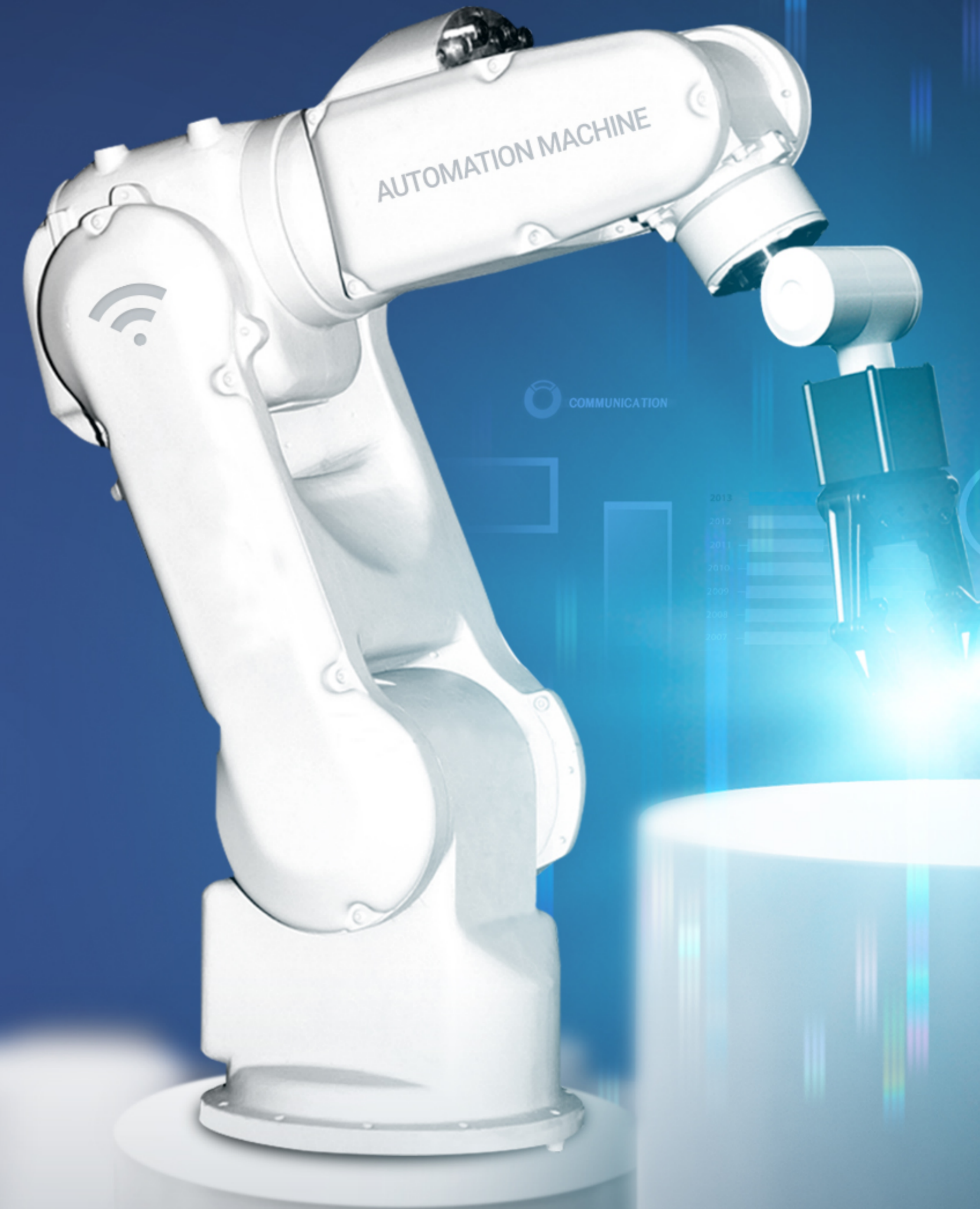

AUTOMATION, SMT & LEAN MANUFACTURING



2002

AMS, Inc was founded in 2002 to provide innovative systems, products, and solutions to manufacturing industries in North and South America



for **18** years

We have engineered automated equipment to implement lean manufacturing process while providing continuous improvement.



2020

Today, AMS is a leader in factory automation. We deliver advanced, technology-driven products and services to enable cost-effective growth for our clients.





BUSINESS INTEGRITY

AMS believe in honesty, diligence and reliability. We hold ourselves to the highest ethical standards to strengthen relationship with our clients and suppliers.



SOCIAL RESPONSIBILITY

AMS is committed to sustainable development. We aim to promote environmental friendly products through research and procurement.



PEOPLE FIRST

AMS value diversity and innovation. We care about people and the impact of our decisions on those around us.

R&D TEAM

AMS Research and Development team focus in advanced technology that will benefit people.
A super-intelligent, human-friendly technology that will provide limitless factory automation.

01 RESEARCH

We study, analyze and develop systems to simplify the work that people do.



02 DEVELOPMENT

We develop new, innovative, and customized systems to increase work productivity while simplifying human tasks.



03 PRODUCTION

We produce efficient and convenient systems to meet client needs

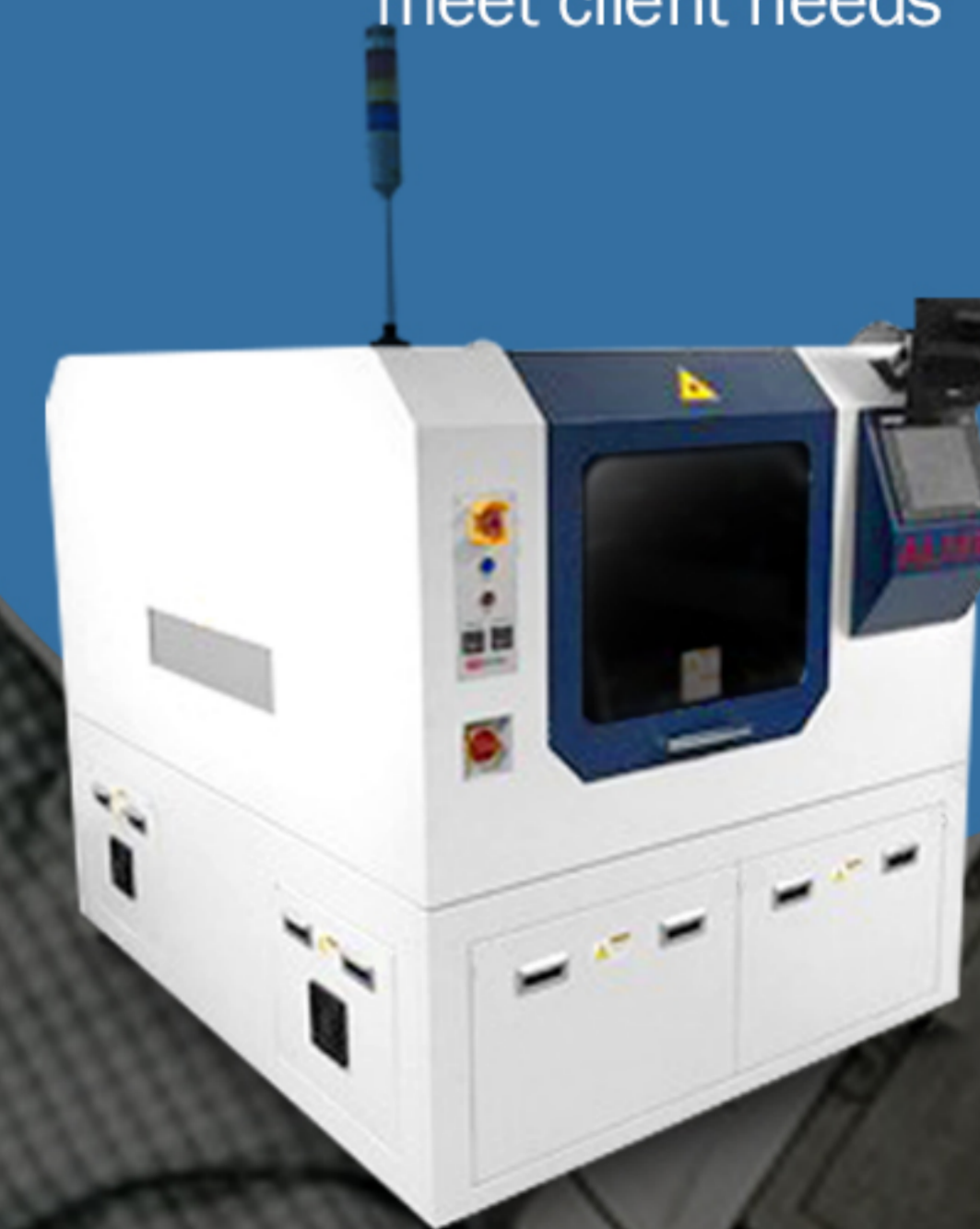

GREEN TECHNOLOGY

At AMS, we think of people and environment first. That's why we focus our investment and research in sustainable growth and products.

Clean Air

ECO Nozzle Cleaner



Reusable paper
 ↓
 Hazardous waste reduction
 ↓
CO2 Emission
 Up to **80%** Decrease

Zero Waste

Aluminum MRS

Aluminum is an endless recyclable material.

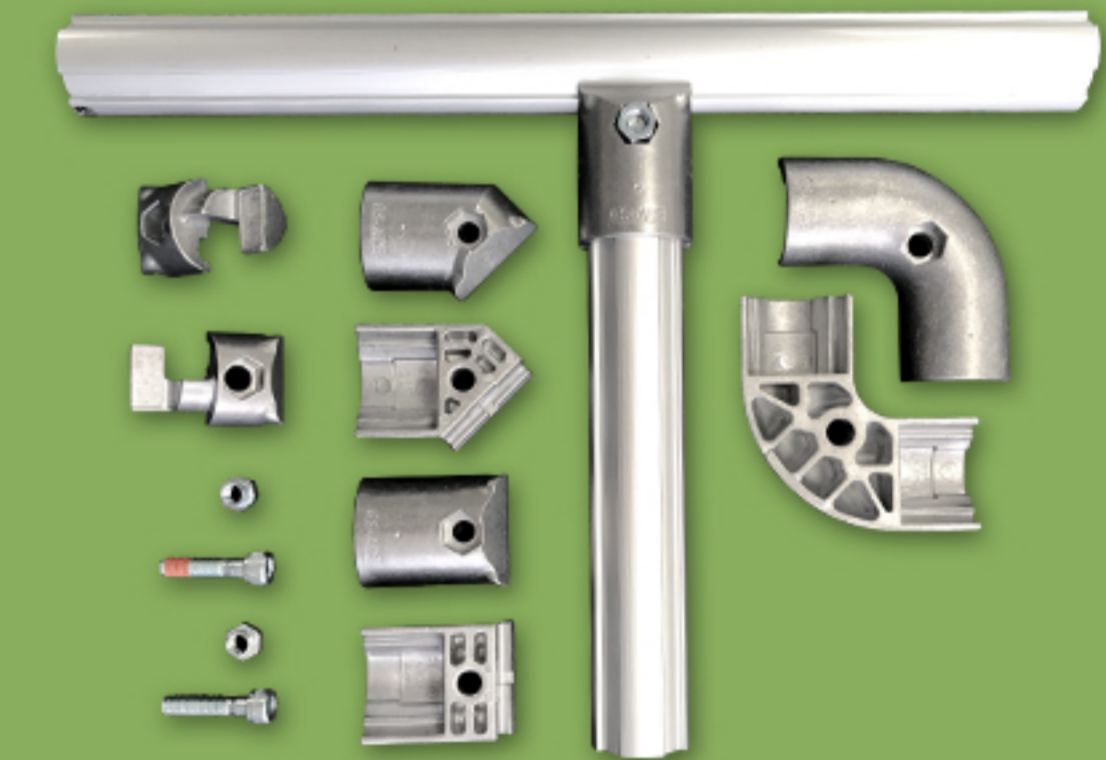

Conserve Energy

Pneumatic Stencil Cleaner



NO Electricity

Environmental pollution Greenhouse gas

DOWN

Green Chemistry

ECO Nozzle Cleaner



- ✓ Avoid harmful substances
- ✓ Use of natural ingredients
- ✓ Protecting nature and humanity







AUTOMATION AND ENGINEERING

State of the art technology
providing production flexibility and
acceleration.

LEAN MANUFACTURING

Lean logistics and material handling
management for production and assembly lines.

SMT SOLUTION

Superior quality components at cost-effective prices
on most major brands of assembly equipment.

ESD CONTROL

Products specifically designed for ESD processes
with high quality and world-class performance.

AUTOMATION & ENGINEERING

Total automated production solutions from engineering consulting, design, and products. Innovated and economical products include SMT Equipment, PCB Handling Conveyor, Laser Marking System, AGV, and ErgoLift.



INSERTION MACHINES
FUSE-TERMINAL-RELAY-ODDFORM



BHU(SMT) CONVEYORS



PCB LASER MARKER



AUTO LABEL PLACER



INKJET MARKING MC



PCB SURFACE CLEANER
(AR TYPE & VACUUM TYPE)



SPI
(SOLDER PASTE INSPECTION)



REFLOW OVEN



AOI
(AUTOMATIC OPTICAL INSPECTION)



PCB ROUTER
(STANDALONE & IN-LINE)

AUTOMATION & ENGINEERING

Total automated production solutions from engineering consulting, design, and products. Innovated and economical products include SMT Equipment, PCB Handling Conveyor, Laser Marking System, AGV, and ErgoLift.



PCB LASER DEPANELIZER



AUTOMATIC MAGAZINE WIDTH
ADJUSTMENT MC



SELECTIVE SOLDERING MC



WAVE SOLDERING MC



AIR BALANCER



COLLABORATIVE ROBOT



CO2, FIBER, UV, GREEN LASER



3KW LASER CUTTING MC
FOR STEEL SHEET



AUTO SCREW/
NUT FASTENING MACHINE



AUTO WELDING ROBOT

LEAN MANUFACTURING

Lean material handling and factory automation possibilities with MRS, AL MRS, EZ-Pro, Micro Deck Panel, and Wire Shelf.

SLIDING RACK



WORK STATION



CARTS (DOLLY)



LINE SIDE RACK

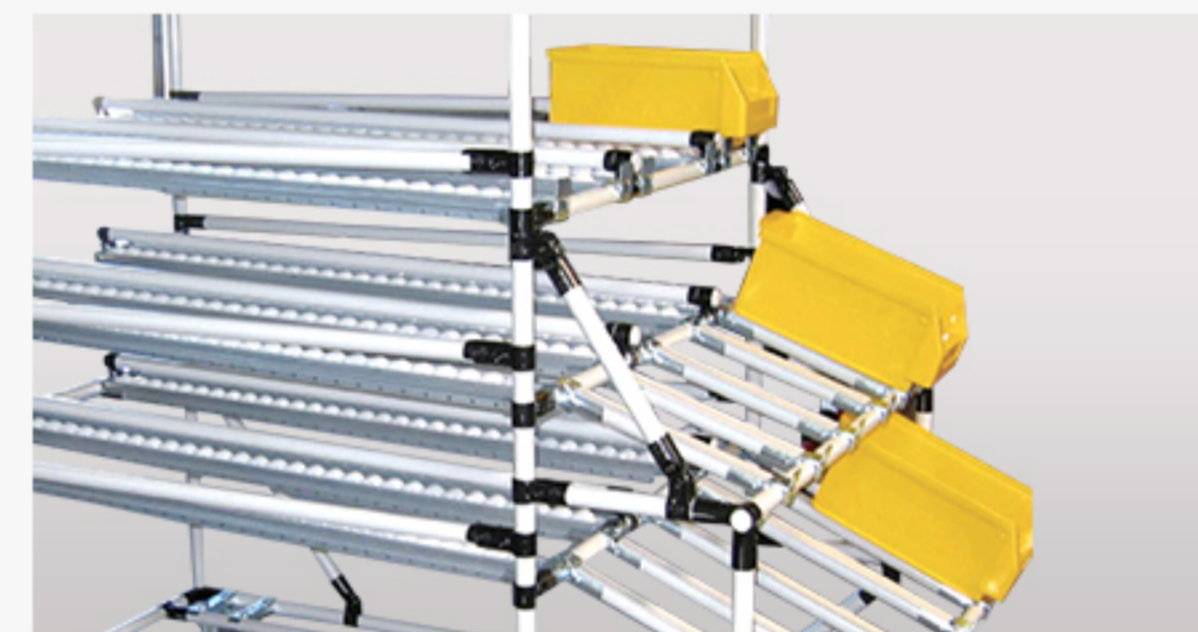

KARAKURI

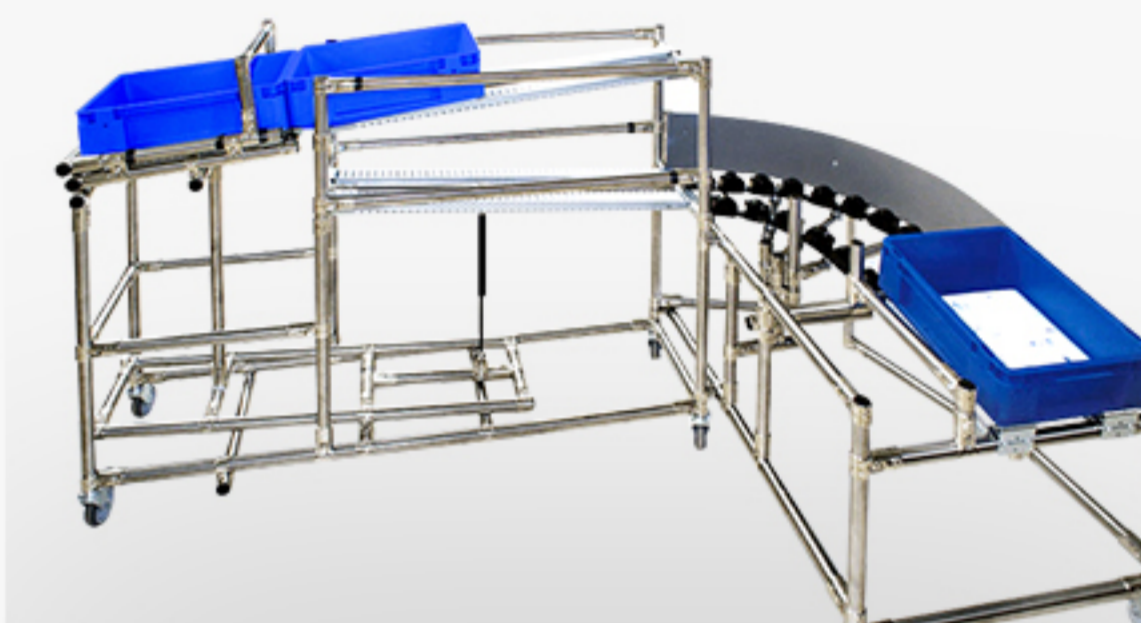

LEAN MANUFACTURING

Lean material handling and factory automation possibilities with MRS, AL MRS, EZ-Pro, Micro Deck Panel, and Wire Shelf.



SMART GATE /
KINETIC WHISKER
S/W



CASTER WHEELS



SCREW DRIVERS



SMART SCREEN



AGV
(AUTOMATIC
GUIDED VEHICLE)



AMR
(AUTONOMOUS
MOBILE ROBOT)



MODULAR
RACKING SYSTEM

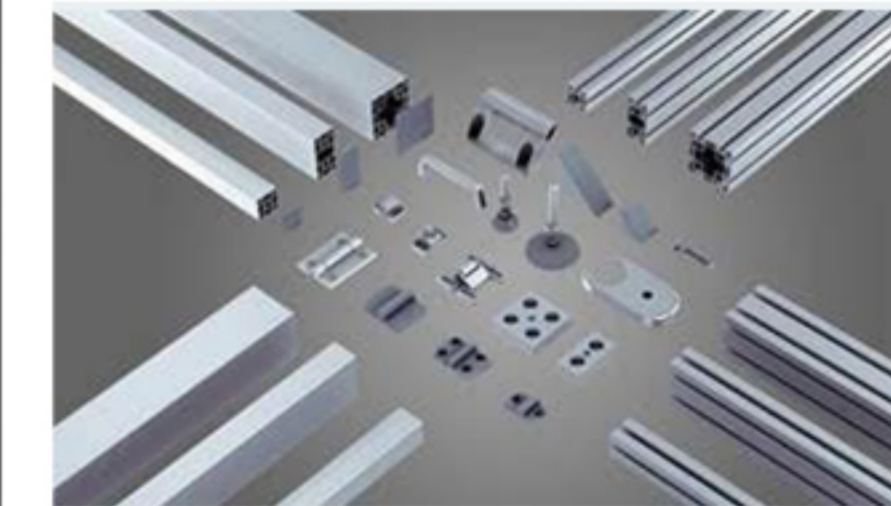

ALUMINUM
PROFI LE



PMP
(PICK TO LIGHT:
POKAYOKE)



POWER PALLET



POWER CART



POWER ROLL



ERGONOMIC LIFT
(AUTOMATIC &
MANUAL)



EZ-PRO
(SCRATCH FREE)

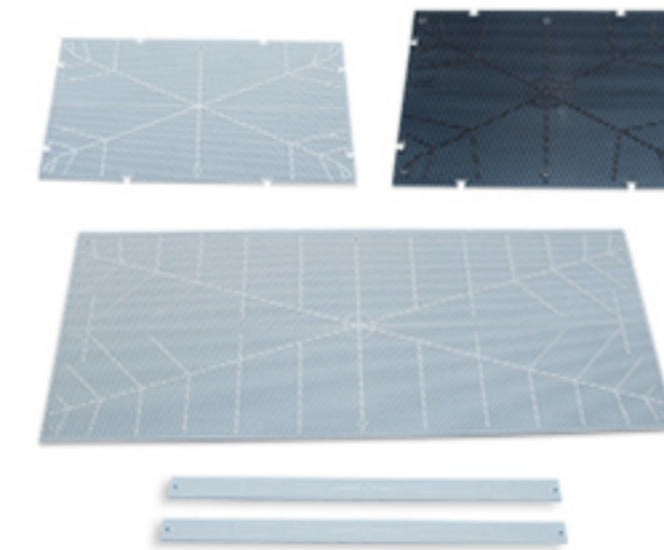

EZ-SLIDE



COLLAPSIBLE/
RETURNABLE
BOXES &
DANPLA SHEET

SMT SOLUTION

Wide variety of SMT Parts with quality from splicing tapes to glue, here you can get most of the parts you need in SMT processes

GO
GREEN



STENCIL MASK CLEANER

GO
GREEN



BHU(SMT) CONVEYORS

GO
GREEN



N2 GENERATOR

GO
GREEN



NOZZLE SUCTION ROUTE
CLEANER

GO
GREEN



NOZZLESCOPE



STRESS ZERO PCB V CUTTER



PCB "V" CUTTER



SMD COMPONENT COUNTER

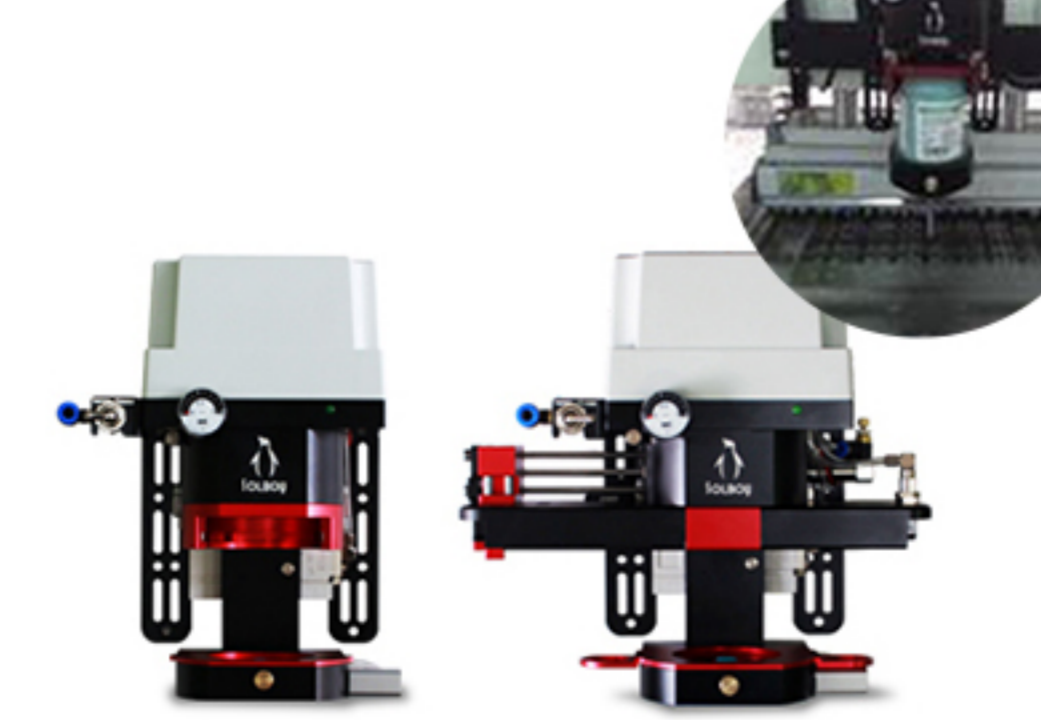

AUTOMATIC SOLDER PASTE
DISPENSER



RH DRY CABINET

SMT SOLUTION

Wide variety of SMT Parts with quality from splicing tapes to glue, here you can get most of the parts you need in SMT processes



STANDARD & CUSTOM NOZZLE



UNDER STENCIL PAPER ROLL

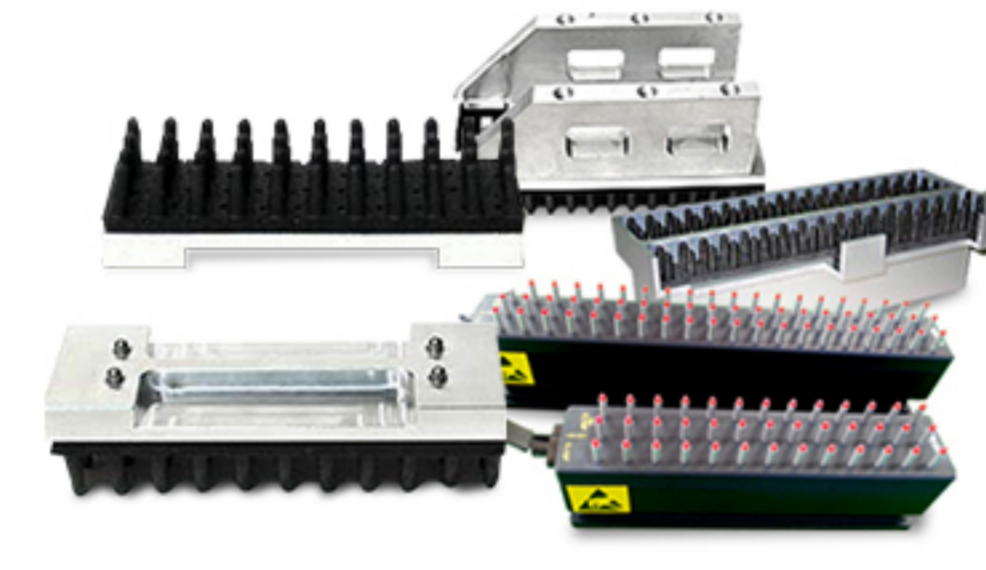

FBUP & MBUP FOR MOUNTER & PRINTER



SQUEEGEE BLADE FOR SCREEN PRINTER

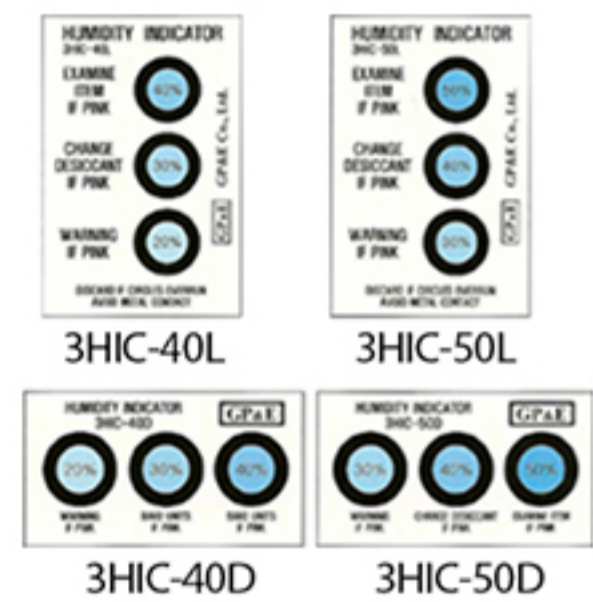

HUMIDITY INDICATING CARD

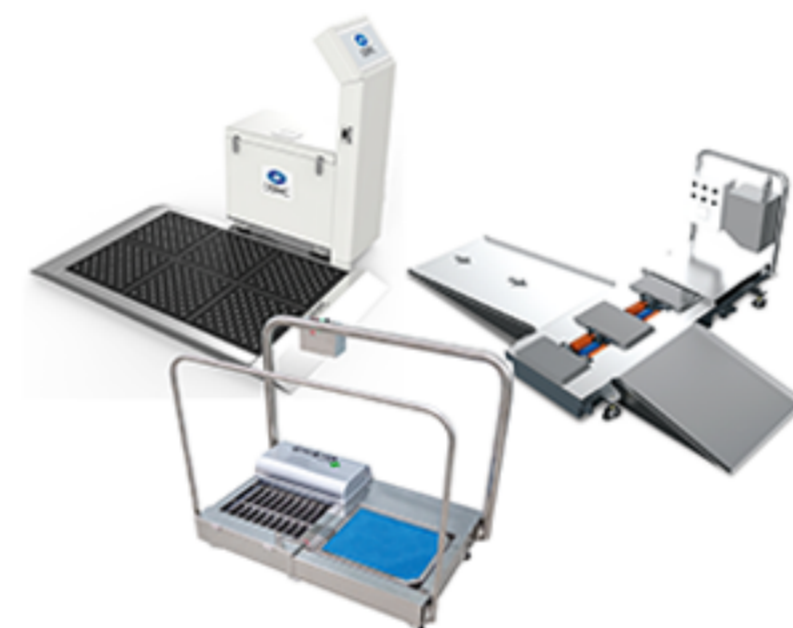

SHOE SOLE/ CASTER WHEEL CLEANER



WAVE CHECKER

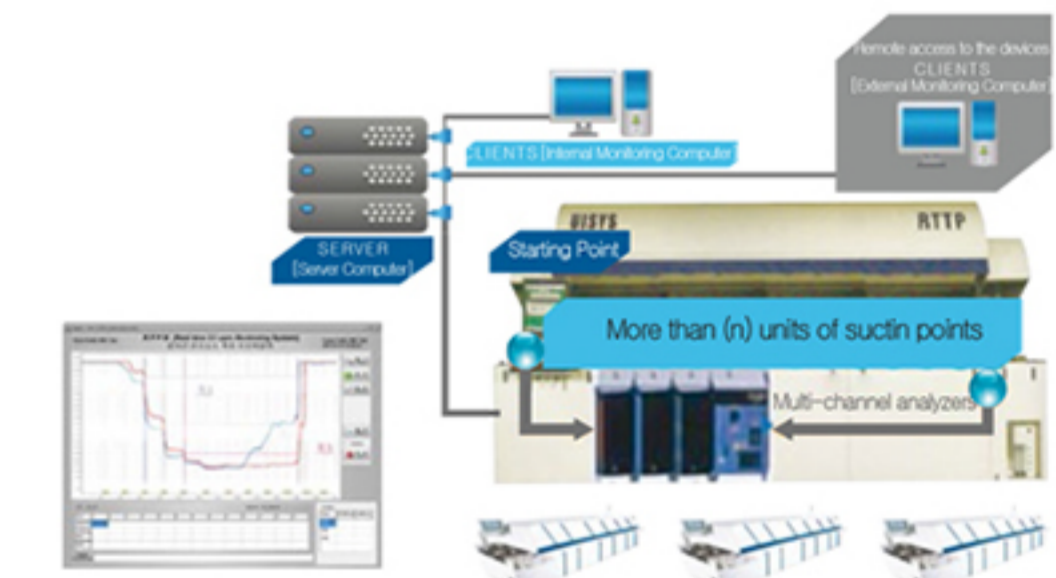

REFLOW CHECKER

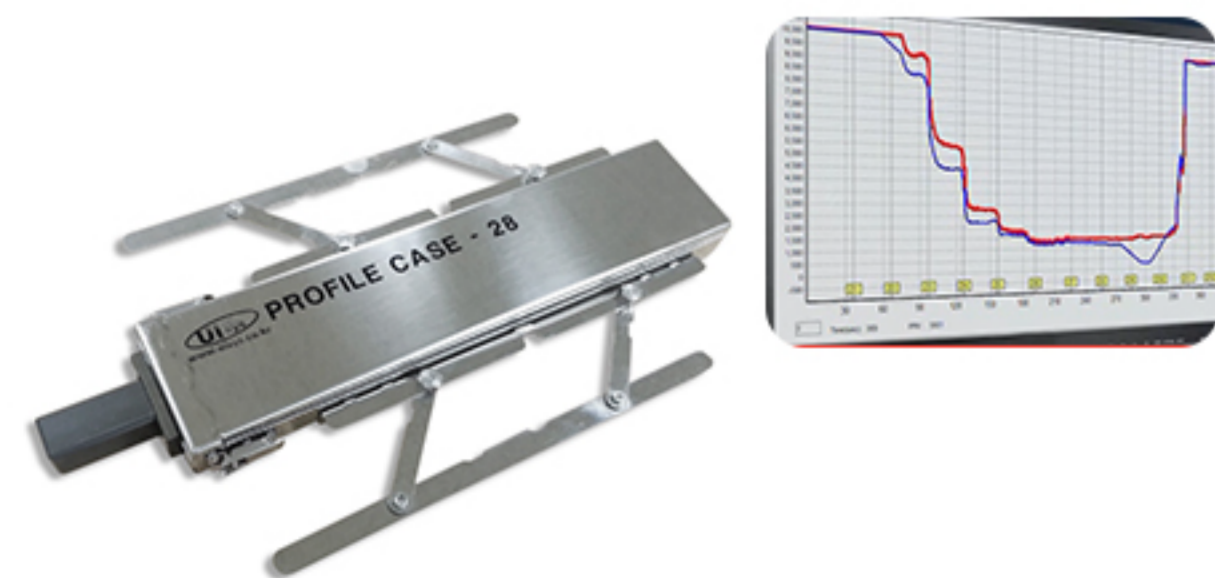

IN-LINE O2 (N2) ANALYZER



UI-HI CAMERA

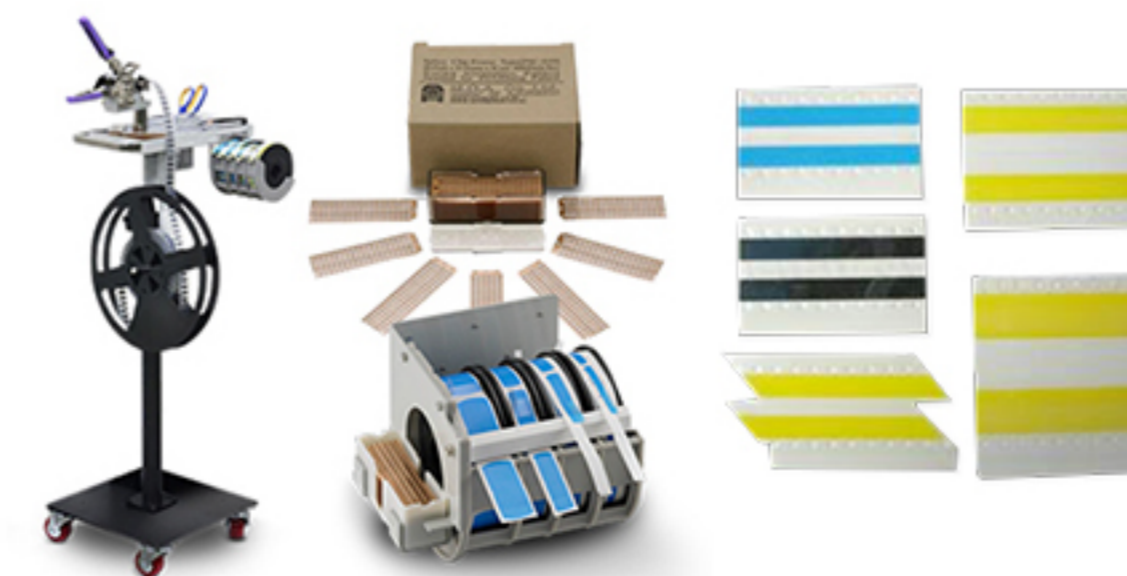

SPLICE TAPES, CLIPS & DEVICE



TAPE/LABEL DISPENSER

ESD CONTROL

Superior quality components at cost-effective prices on most major brands of assembly equipment.



SOFT X-RAY &
CORONA IONIZER



CONDUCTIVE MAGAZINE
RACK

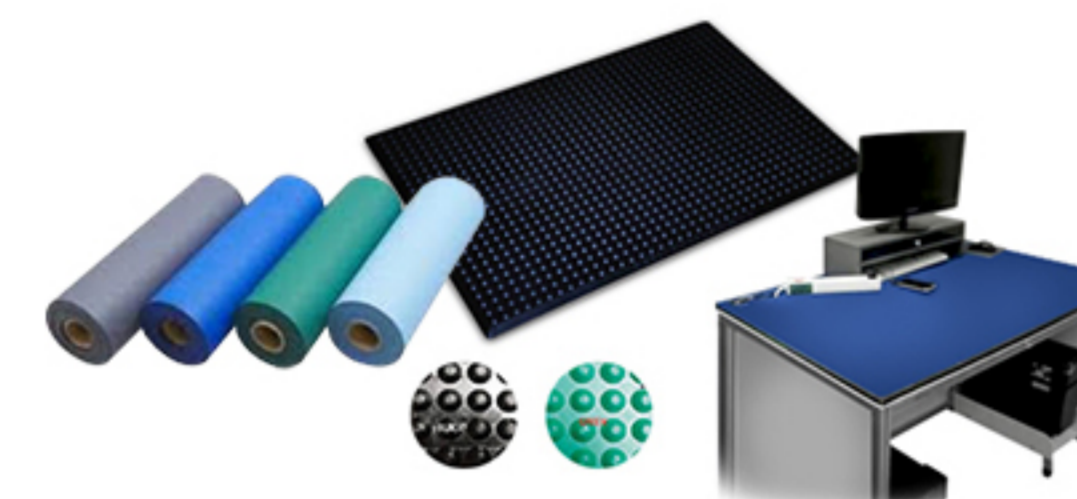

ESD TABLE/
FLOOR ANTI-FATIGUE MAT

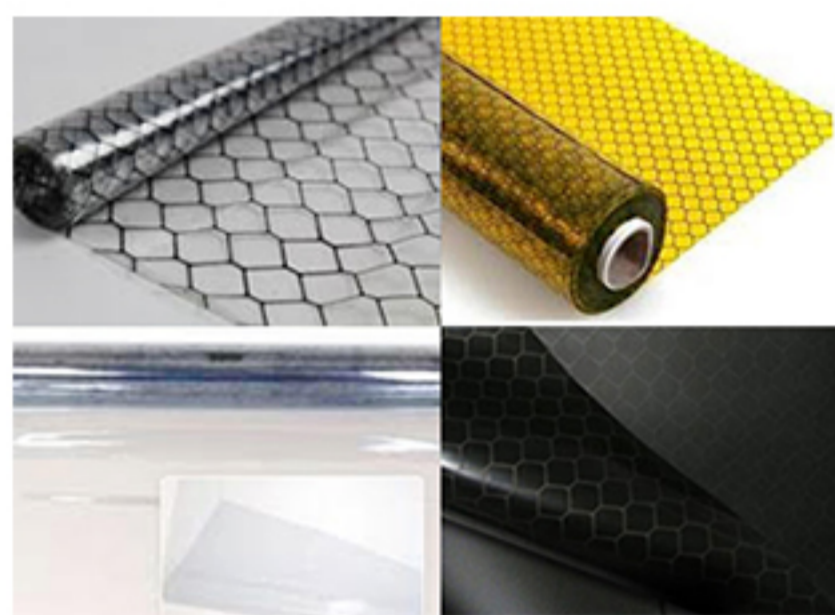

ESD PVC CURTAIN



ESD CLEAN
ROOM PVC FILM

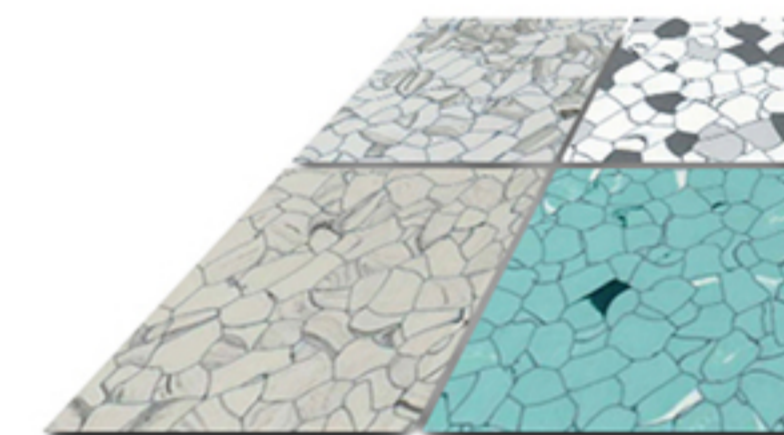

CONDUCTIVE TILES



HAND CLEANING
ROLLER



HAND-HELD
ELECTROSTATIC
FIELD METER



ESD TESTER



TURNSTILE GATE



ANTISTATIC HEEL
STRAP /
WRIST STRAP

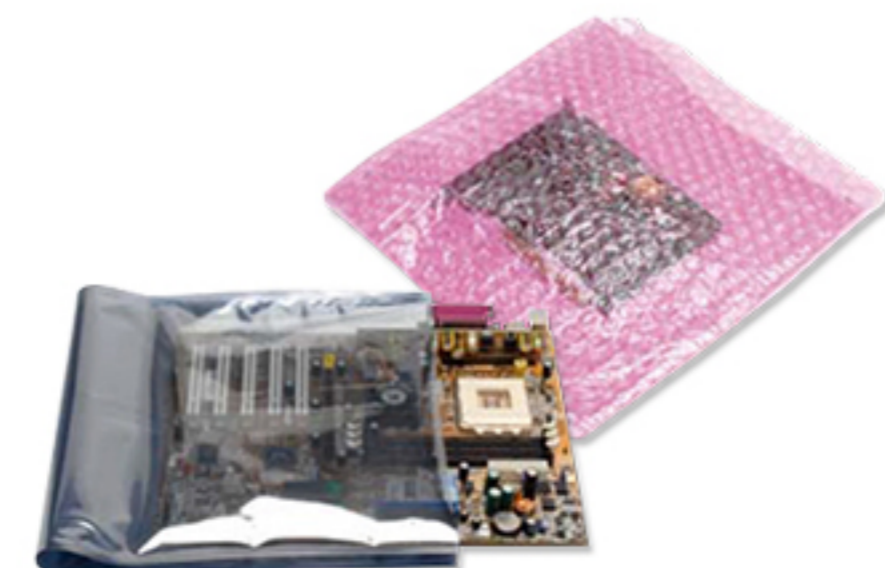

ANTISTATIC
MOISTURE
PROOF BAG /
SHIELDING
BAGS



CONDUCTIVE
CIRCULATION
BOXES

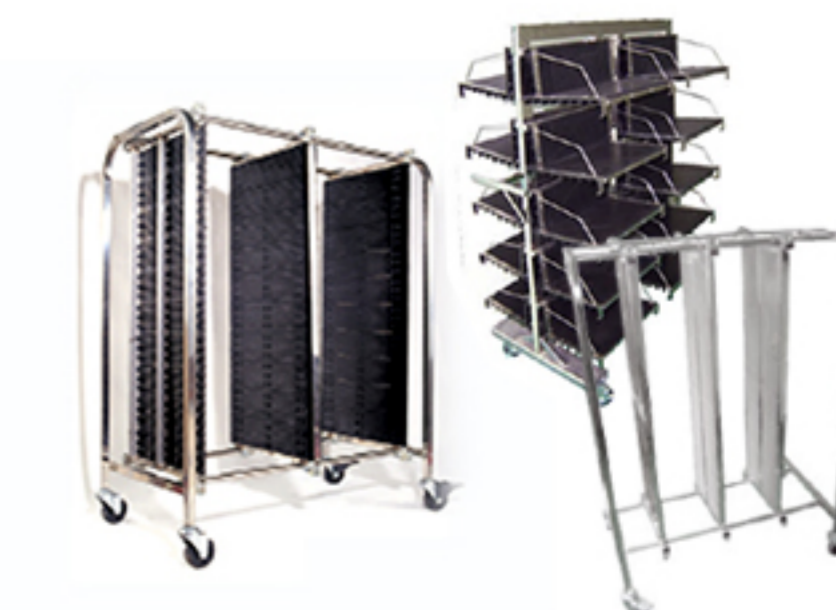

CONDUCTIVE
PCB CARTS

AMS, INC.

Advanced Mechatronics Solutions, Inc
10030 Via de la Amistad, San Diego, CA 92154

T: +1 (619) 661-5985

F: +1 (619) 661-5995

E: ams@ams-fa.com

**AMS Dynamics, Inc.**

2979 Pacific Drive Suite A Norcross, GA 30071

T: +1 (770) 864-5394

F: +1 (678) 691-1847

E: infoATL@ams-fa.com

**AMS de MEXICO**

AMS Factory Automation de Mexico SA de CV
Polígono Buenavista – Calle Cementera Lote 9, Mz 8
Ejido Buenavista - Querétaro, Qro. 76225

T: +52 (442) 312-0920

E: mexico@ams-fa.com

**AMS do BRASIL**

AMS do Brasil Automação Industrial Ltda

Rua Laerte de Paiva, 344, Bairro Macuco, Valinhos –SP–CEP 13279.451

T: +55 (19) 3849-5555

E: quote@ams-fa.com



ADVANCED MECHATRONICS SOLUTIONS, INC

Automation, SMT & Lean manufacturing

To view additional products..

www.ams-fa.com

